

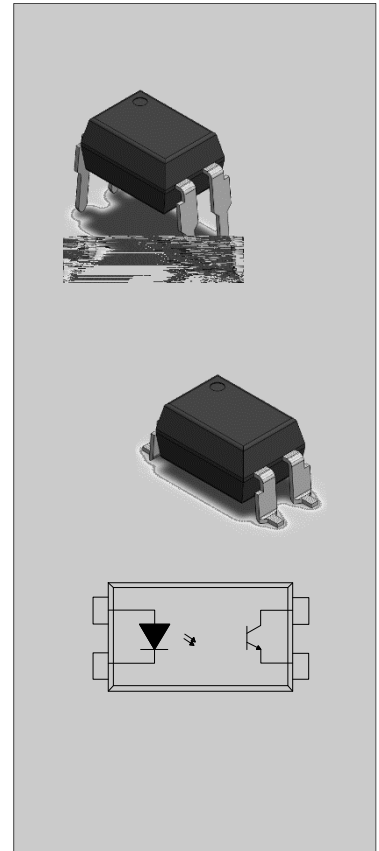

DESCRIPTION:

MAIN FEATURES



ABSOLUTE MAXIMUM RATINGS

		①	
		②	
			°C
			°C
			°C



			°C
--	--	--	----

NOTE1: 100 s pulse, 100Hz frequency

NOTE2: AC for 1minute, R.H.=40~60%

ELECTRICAL CHARACTERISTICS



ORDERING INFORMATION

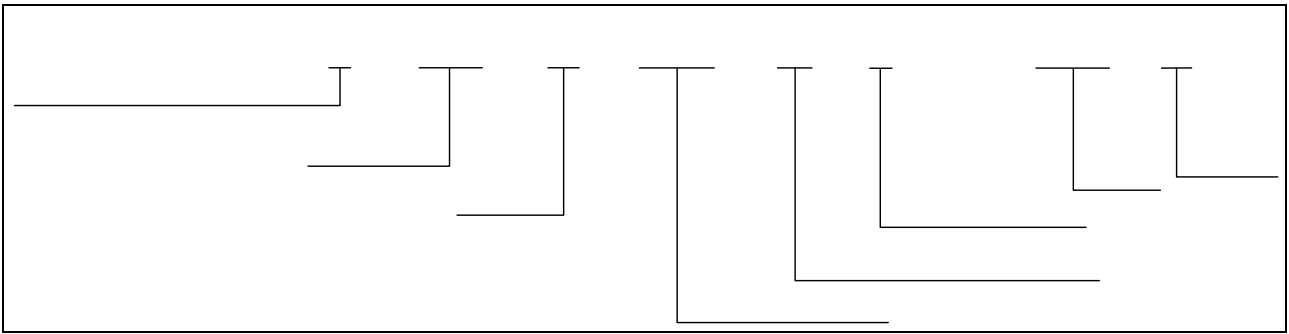

Packing Quantity			
Option	Quantity	Quantity - Inner box	Quantity -Outer box
DIP	100 Units/Tube	32 Tubes/Inner box	10 Inner box/Outer box =32k Units
SMD(T1/T2)	1500 Units/Reel	3 Reels/Inner box	5 Inner box/Outer box =22.5k Units
SMD(T3/T4)	1000 Units/Reel	3 Reels/Inner box	5 Inner box/Outer box =15k Units

MARKING

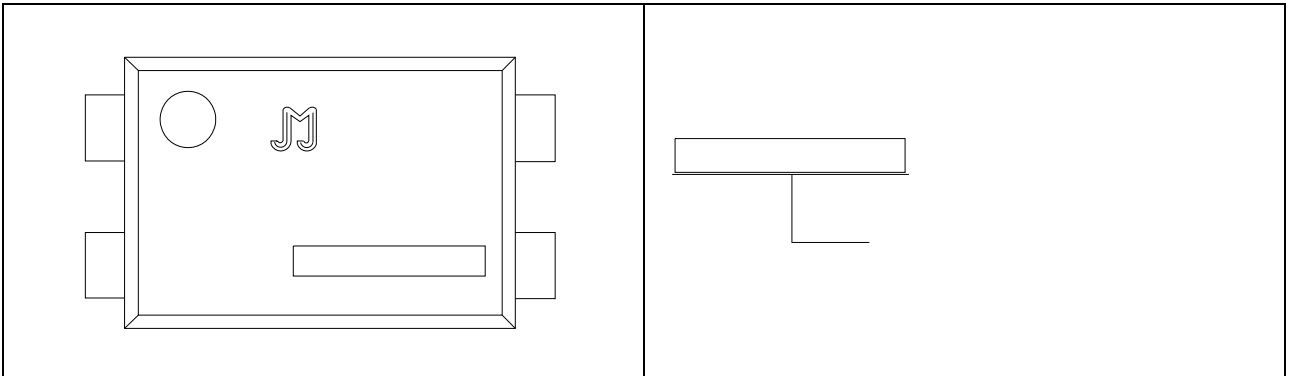



Characteristics Curves

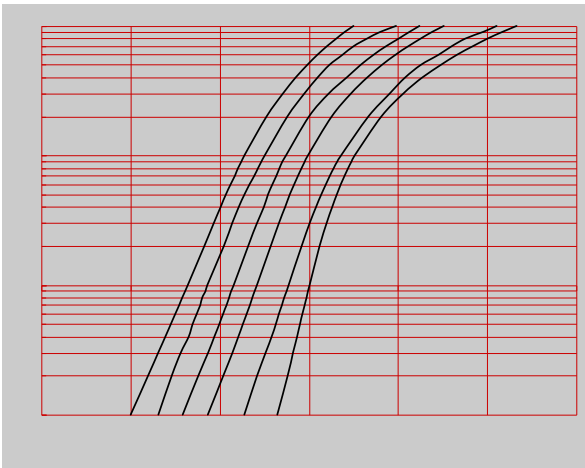
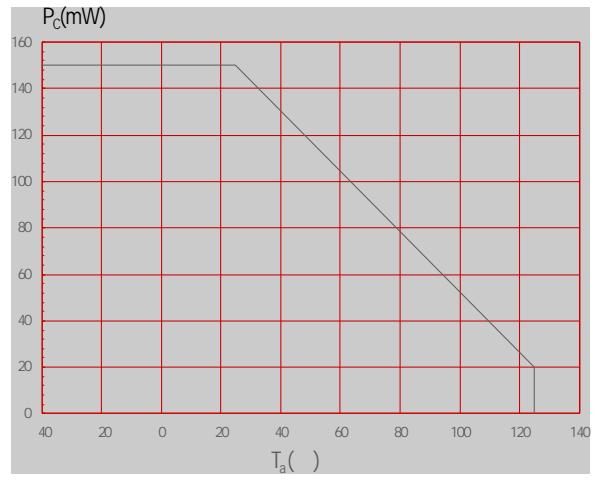
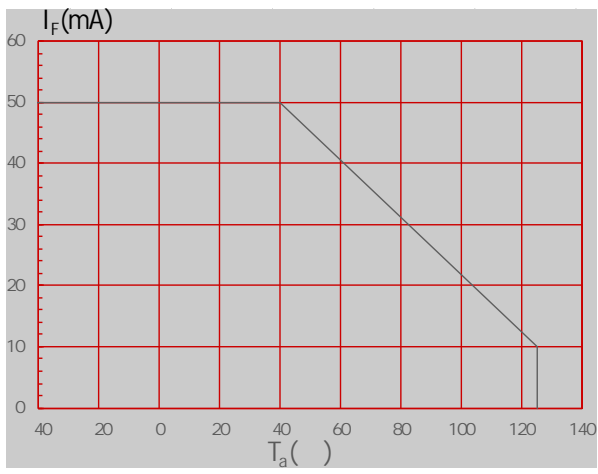

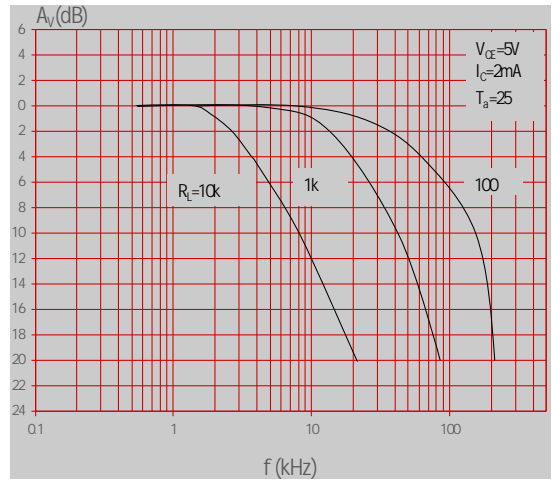
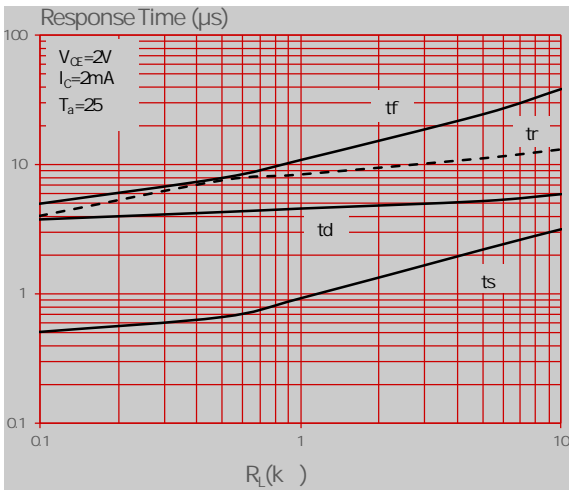
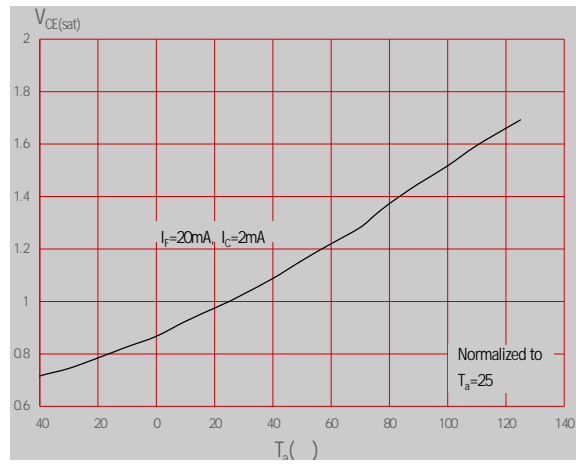
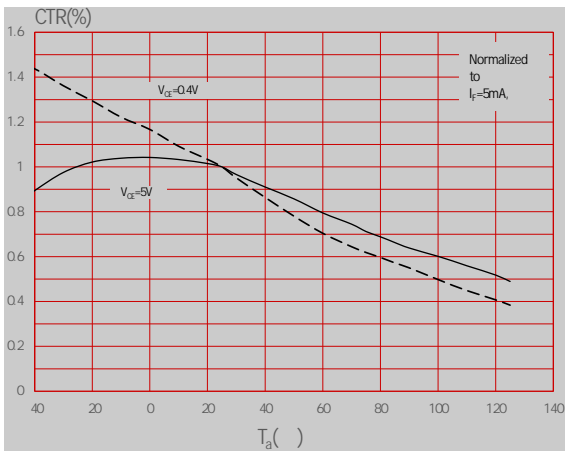



RECOMMENDED SOLDER MASK (Dimensions in mm unless otherwise stated)

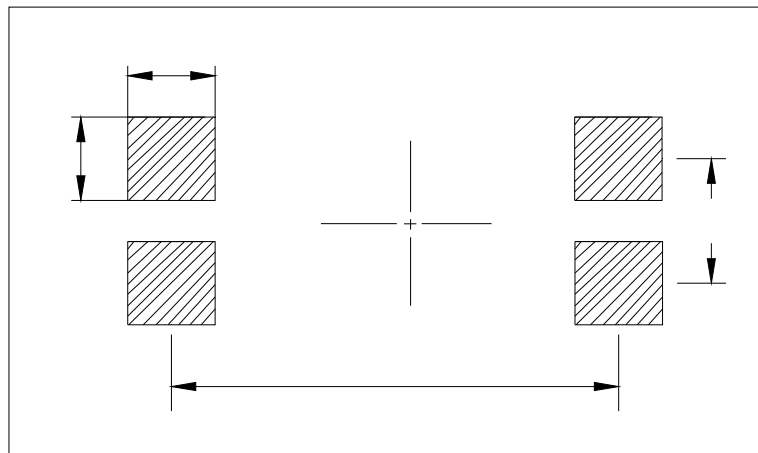

TUBE SPECIFICATIONS (Dimensions in mm unless otherwise stated)

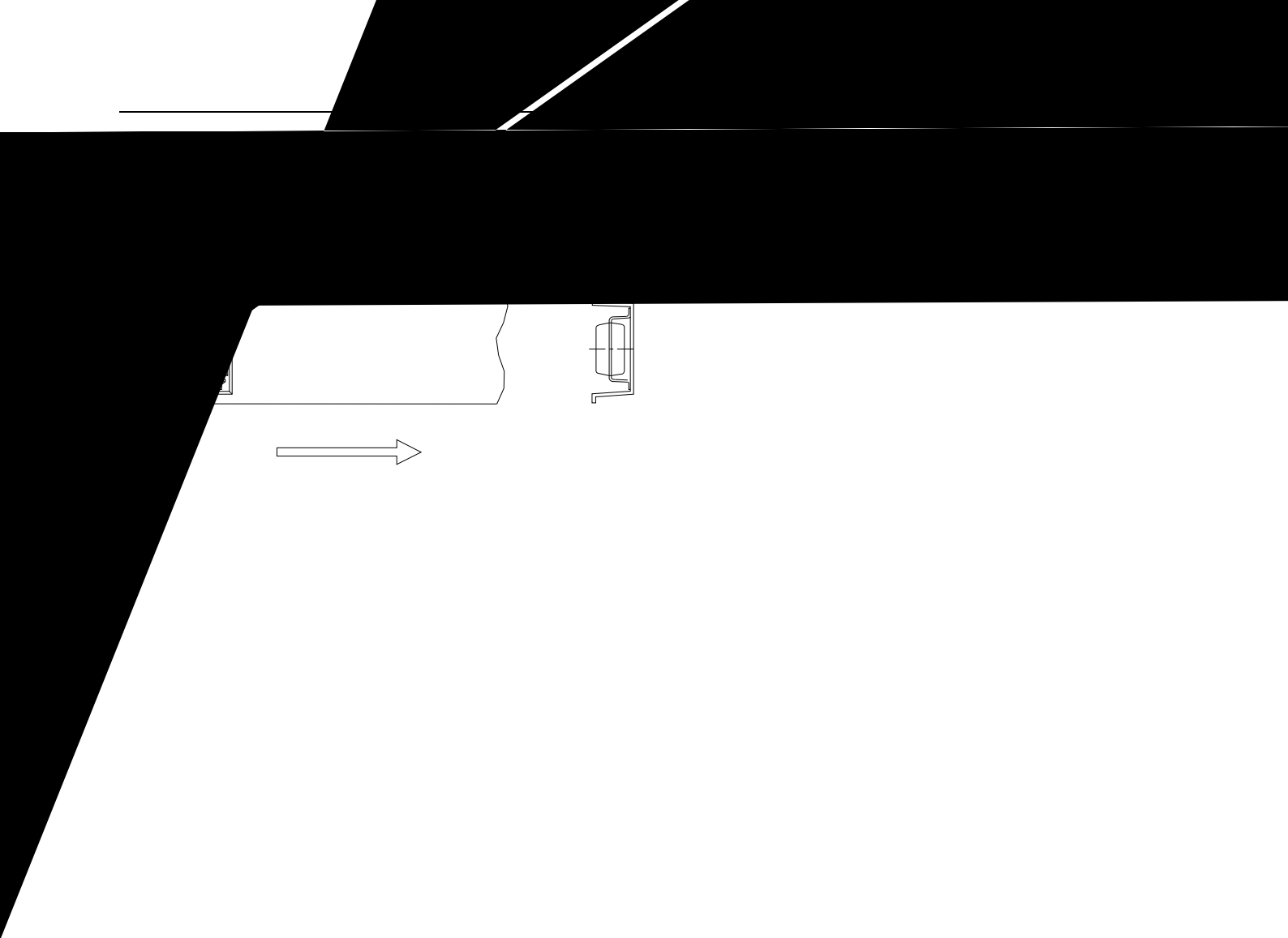



REFLOW INFORMATION

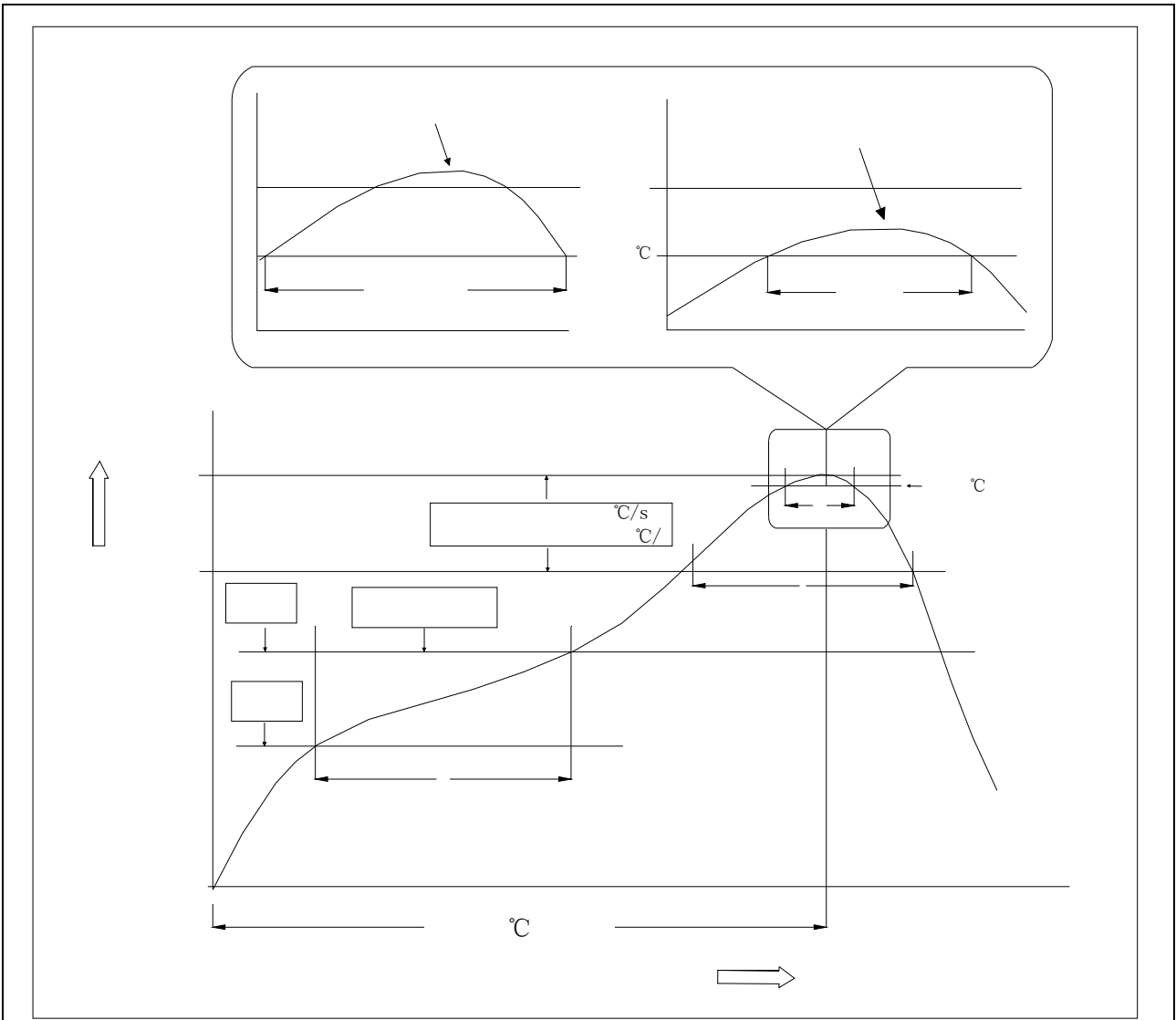

	°C	°C
	°C	°C
	°C	°C
	°C	°C
	°C °C °C	°C °C °C
°C °C		
	°C	°C
°C		



WAVE SOLDERING

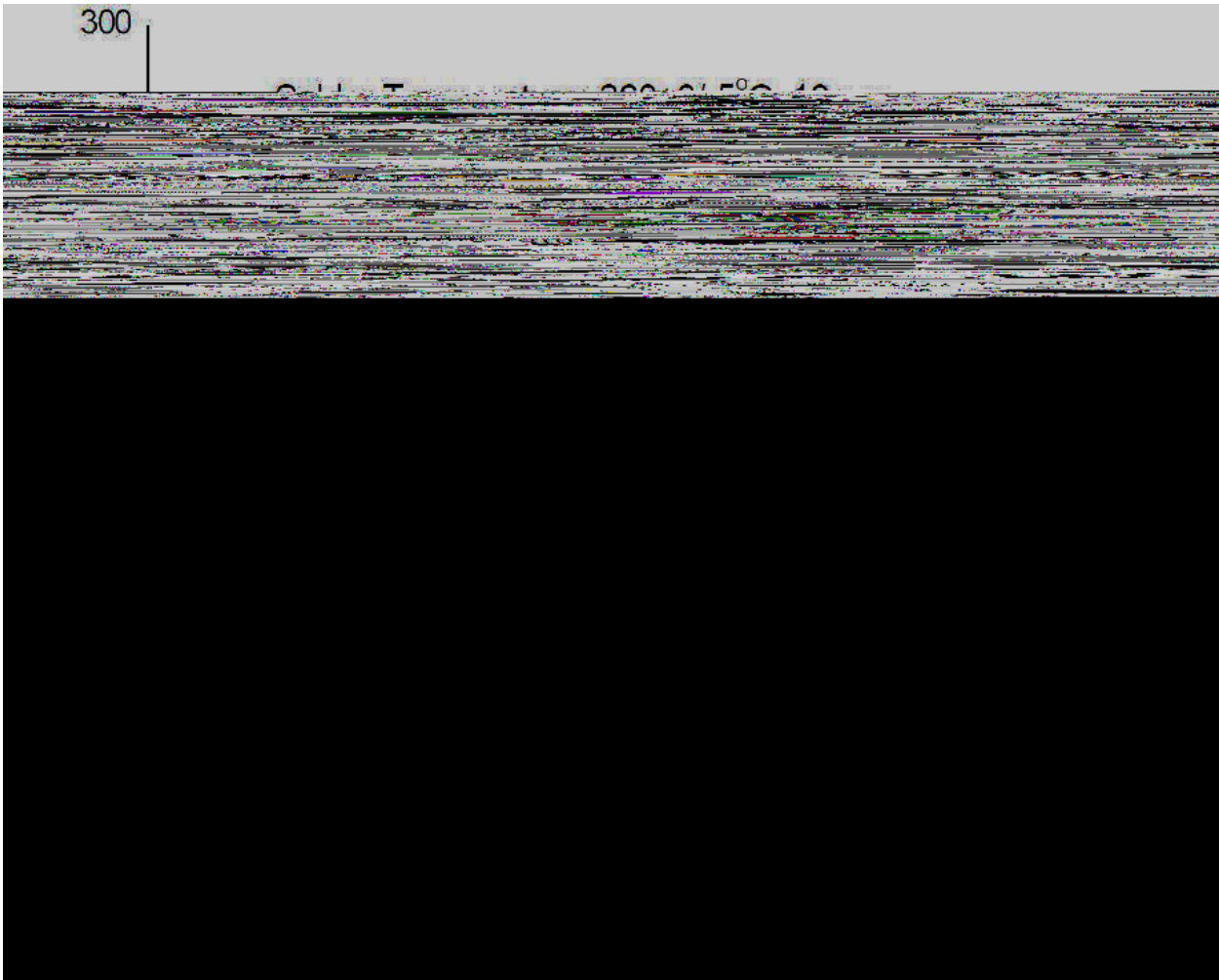

HAND SOLDERING BY SOLDERING IRON

± °C

