



DESCRIPTION:

The products are transistor opto-couplers in a plastic SOP4 package. The device combines an AlGaAs infrared emitting diode as the emitter which is optically coupled to a silicon planar phototransistor detector. With the robust coplanar double mold structure, the device provides the most stable isolation feature. The products are widely used in switch mode power supplies, programmable controllers, household appliances and office equipment.

MAIN FEATURES

High isolation 3750 VRMS

Operating temperature range -40°C to 110°C

RoHS & REACH Compliance

HBM: H3A; MM: M4; CDM:C3

CQC approved

VDE approved

UL approved



ABSOLUTE MAXIMUM RATINGS (Temperature=25°C)

Input	Forward Current	I_F	50	mA
	Peak Forward Current	I_{FP}	1	A
	Reverse Voltage	V_R	6	V
	Power Dissipation	P_D	75	mW
Output	Collector-emitter Voltage	V_{CEO}	80	V
	Emitter-collector Voltage	V_{ECO}	6	V
	Collector Current	I_C	50	mA
	Power Dissipation	P_C	150	mW
Total Power Dissipation		P_{tot}	225	mW
Isolation Voltage		V_{iso}	3750	Vrms
Operating Temperature		T_{opr}	-40~+110	
Junction Temperature		T_j	125	



Storage Temperature	T _{stg}	-55~+125	
Soldering Temperature	T _{sol}	260	

NOTE1 μ

NOTE2

ELECTRICAL CHARACTERISTICS (Temperature=25°C)

Input	Forward Voltage	V _F	I _F =±10mA	-	1.2	1.5	V
	Terminal Capacitance	C _t	V=0, f=1MHz	-	10	-	pF
Output	Collector-Emitter dark current	I _{CEO}	V _{CE} =20V, I _F =0	-	-	100	nA
	Collector-Emitter breakdown voltage	BV _{CEO}	I _C =0.1mA I _F =0	80	-	-	V
	Emitter-Collector breakdown voltage	BV _{ECO}	I _E =0.1mA I _F =0	6	-	-	V
Transfer Characteristics	Current transfer ratio	CTR	I _F =±1mA V _{CE} =5V	20	-	400	%
	Collector-Emitter Saturation Voltage	V _{CE(sat)}	I _F =±20mA I _C =1mA	-	0.07	0.2	V
	Isolation resistance	R _{IO}	DC500V 40~60%R.H.	10 ¹²	10 ¹⁴	-	
	Floating Capacitance	C _{IO}	V=0, f=1MHz	-	0.4	1	pF
	Cut-off Frequency	f _c	V _{CE} =5V, I _C =2mA R _L =100Ω, -3dB	-	80	-	kHz
	Rise Time	t _r	V _{CE} =2V, I _C =2mA R _L =100Ω	-	4	18	μs
	Fall Time	t _f		-	5	18	μs
	Response Time	t _{on}		-	7	25	μs
t _{off}		-		6	25	μs	

NOTE1



ORDERING INFORMATION

J	OC	T	354	B	-M4	/
JieJie Microelectronics Co., Ltd.	Opto Coupler	Transistor	Marketization Model	CTR Rank:A/B/None	SOP4	None:T1 R:T2

Packing Quantity	
Option	Quantity

MARKING

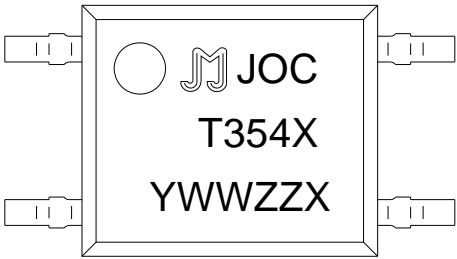
	<p><u>YWWZZX</u></p> <p>LOT NO.</p>
---	-------------------------------------



Characteristics Curves

Max. Allowable LED Forward Current vs. Ambient Temperature

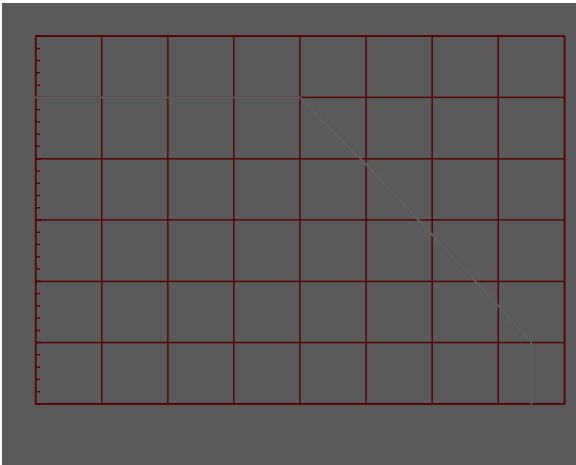

Collector Power Dissipation vs. Ambient Temperature

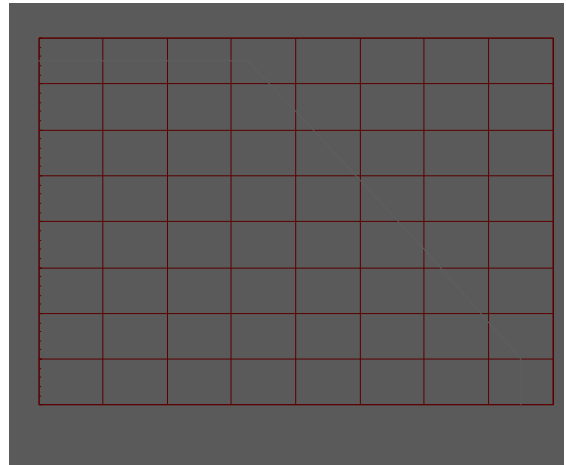

Forward Current vs. Forward Voltage

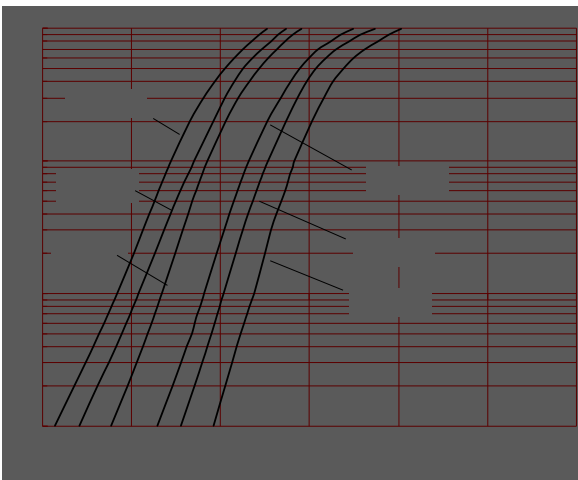

Normalized Collector Dark Current vs. Ambient Temperature

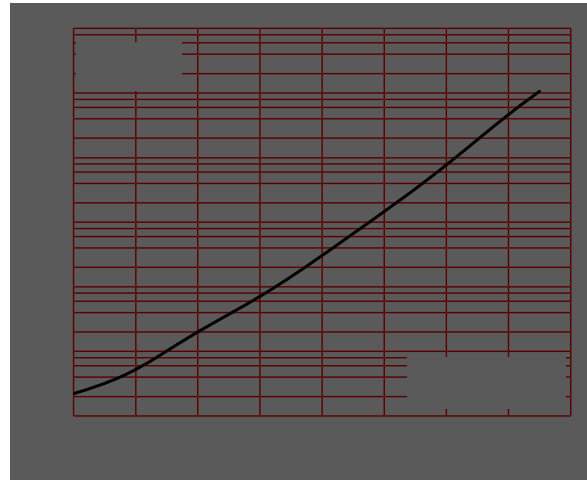

Collector Current vs. Collector-emitter Voltage

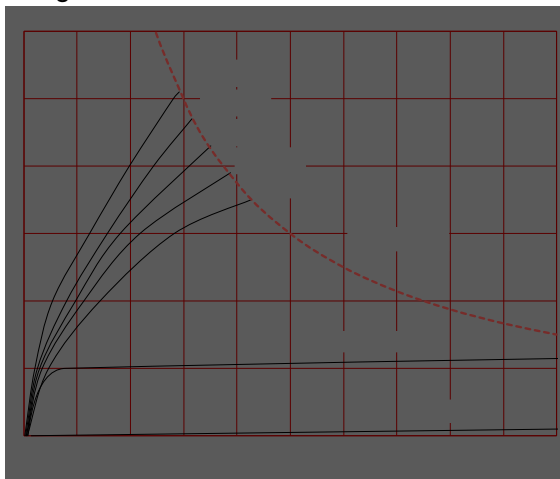

Normalized Current Transfer Ratio vs. Forward Current

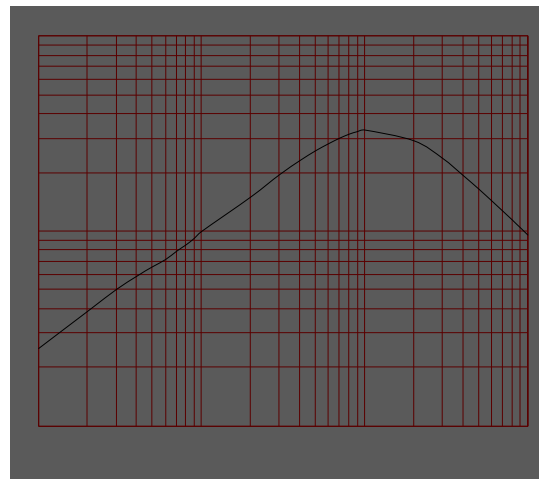



Normalized Current Transfer Ratio vs. Ambient Temperature

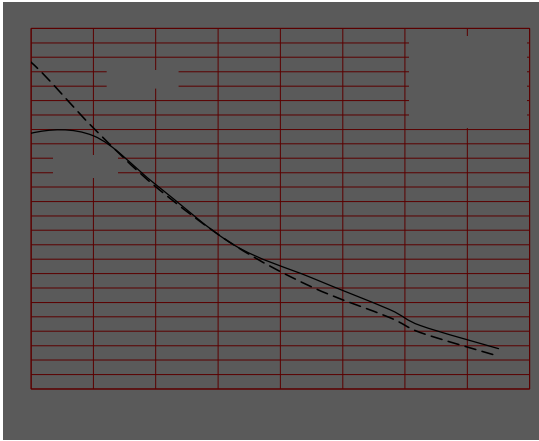

Normalized Collector-emitter Saturation Voltage vs. Ambient Temperature

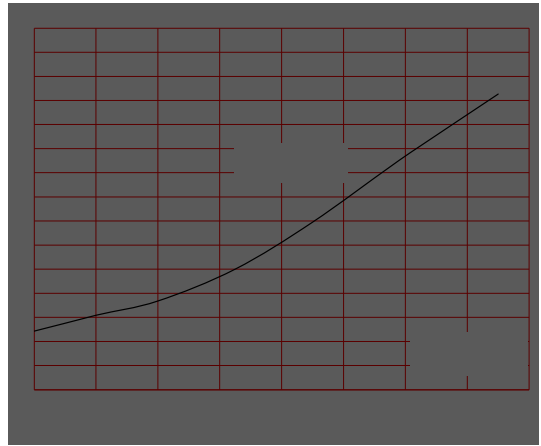

Response Time vs. Load Resistance

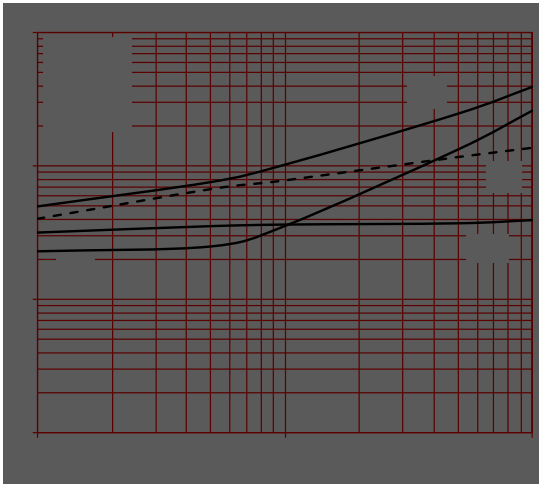

Frequency Response

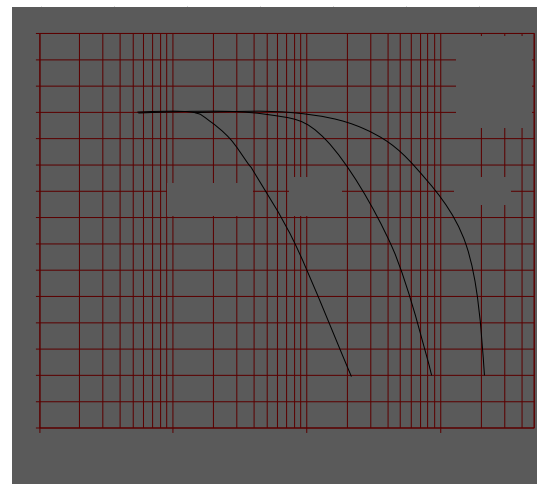

Test Circuits

Test Circuits of Response Time

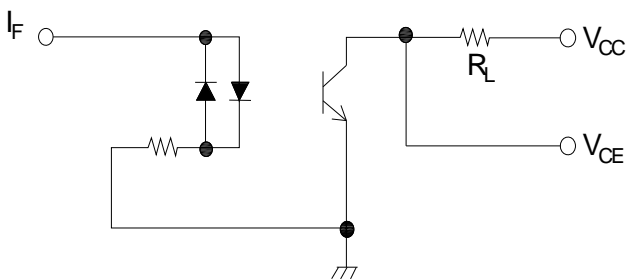

Curves of Response Time

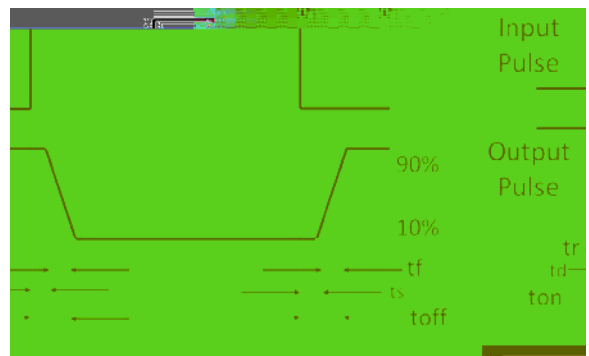



Package Dimension (Unit: mm)

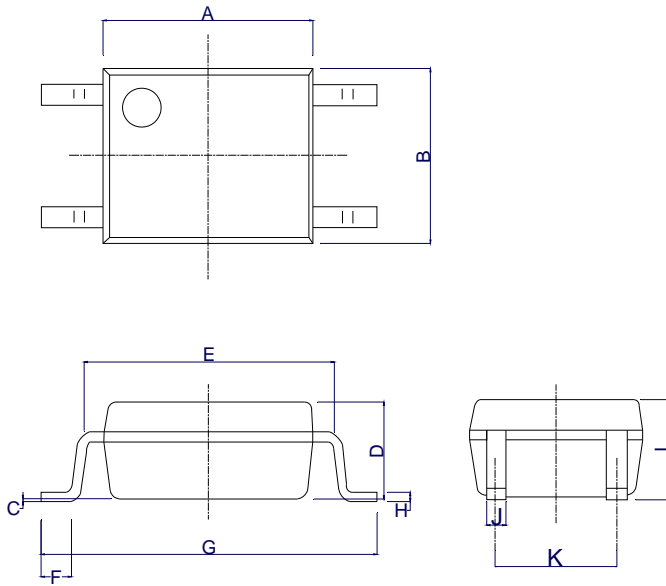

Ref.	Dimensions					
	Millimeters			Inches		
	Min.	Typ.	Max.	Min.	Typ.	Max.
A	4.40		4.80	0.173		0.189
B	3.60		4.20	0.142		0.165
C	0.00		0.20	0.000		0.008
D	1.90		2.30	0.075		0.091
E	5.00		5.60	0.197		0.220
F	0.34		0.94	0.013		0.037
G	6.70		7.30	0.264		0.287
H	0.10		0.30	0.004		0.012
I	2.00		2.40	0.079		0.094
J	0.25		0.55	0.010		0.022
K	2.29		2.79	0.090		0.110

RECOMMENDED SOLDER MASK (Dimensions in mm unless otherwise stated)

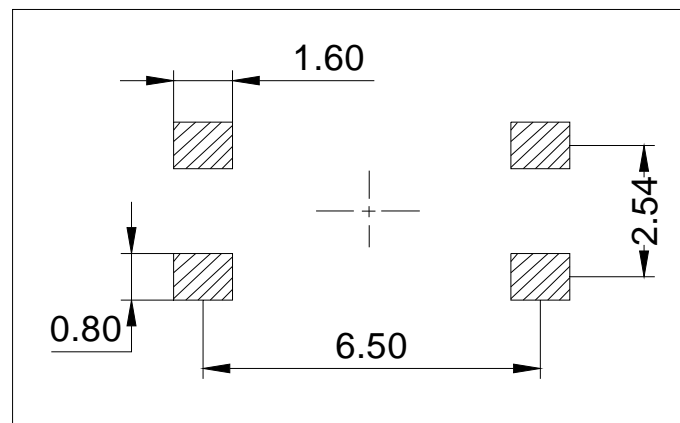



CARRIER TAPE SPECIFICATIONS (Dimensions in mm unless otherwise stated)

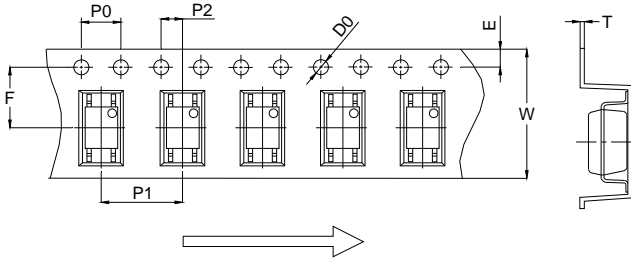

Ref.	Dimensions					
	Millimeters			Inches		
	Min.	Typ.	Max.	Min.	Typ.	Max.
D0		1.50	1.60		0.059	0.063
P0	3.90	4.00	4.10	0.154	0.157	0.161
P1	7.90	8.00	8.10	0.311	0.315	0.319
P2	1.90	2.00	2.10	0.075	0.079	0.083
E	1.65	1.75	1.85	0.065	0.069	0.073
F	4.40	4.50	4.60	0.173	0.177	0.181
T	0.25	0.30	0.35	0.010	0.012	0.014
W	11.90	12.00	12.30	0.469	0.472	0.484

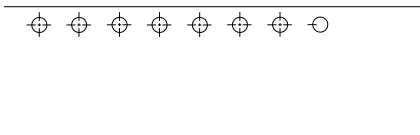



REFLOW INFORMATION

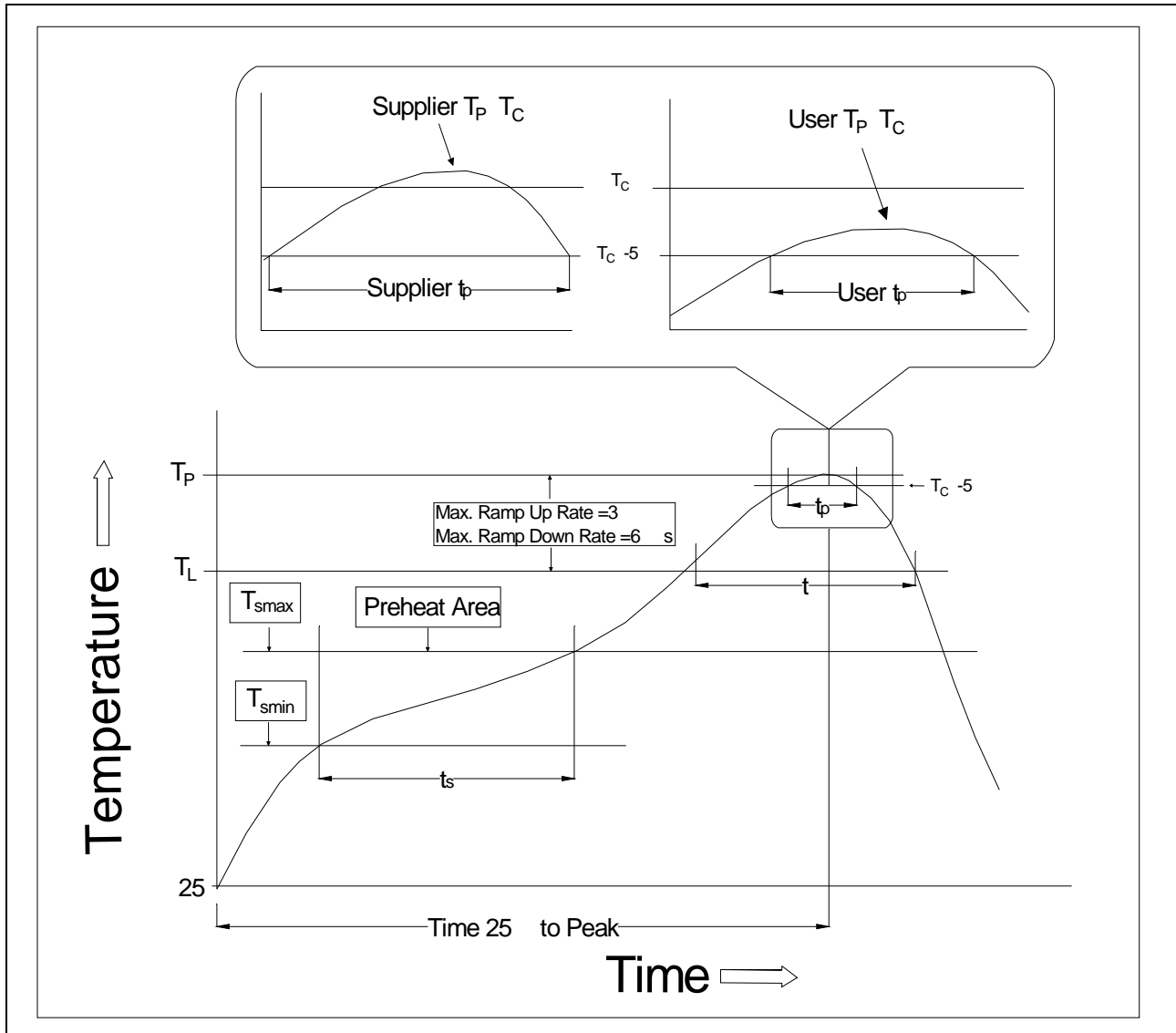

Temperature Min. (T _{smin})	100	150
Temperature Max. (T _{smax})	150	200
Time (t _s) from (T _{smin} to T _{smax})	60-120 seconds	60-120 seconds
Ramp-up Rate (t _L to t _P)	3 /second max.	3 /second max.
Liquidus Temperature (T _L)	183	217
Time (t _L) Maintained Above (T _L)	60-150 seconds	60-150 seconds
Peak Body Package Temperature	235 +0 /-5	260 +0 /-5
Time (t _P) within 5 of 260	20 seconds	30 seconds
Ramp-down Rate (T _P to T _L)	6 /second max.	6 /second max.
Time 25 to Peak Temperature	6 minutes max.	8 minutes max.



Note:

1. Reflow soldering is recommended at the temperatures and times shown, no more than three times.
2. Avoid direct contact between the epoxy body and any tools or surfaces exceeding its maximum storage temperature.
3. Application of pressure on the epoxy body is prohibited at elevated temperatures. In specific scenarios, any applied force must not exceed 2.5N.
4. Ensure the component has cooled to ambient temperature before proceeding with any subsequent manufacturing steps.
5. The component has a shelf life of one year when stored under standard conditions.

l ec