



JOCSR21X,JOCSR31X-D5P/S Series

Rev.A.1.0

DESCRIPTION:

The products are 5-pin thyristor opto-couplers. The device combines an AlGaAs infrared emitting diode as the emitter which is optically coupled to a monolithic silicon random-phase photo triac in a plastic DIP5 package with different lead forming options. With the robust coplanar double mold structure, the device provides the most stable isolation feature. The products are widely used in solenoid/valve controls, lighting controls, motor controls, temperature controls, static AC power switches, solid state relays, interfacing microprocessors up to 265 V_{AC} peripherals.



MAIN FEATURES

- High isolation 5000 VRMS
- DC input with random-phase photo triac output
- Operating temperature range -55
- REACH & RoHS compliance
- HBM: H3A; MM: M4; CDM: C3
- CQC approved
- VDE approved
- UL approved

ABSOLUTE MAXIMUM RATINGS (Temperature=25°C)

Parameter		Symbol	Value	Unit	
Input	Forward Current	I _F	50	mA	
	Peak Forward Current	I _{FP}	1 ^①	A	
	Reverse Voltage	V _R	6	V	
	Power Dissipation	P _D	75	mW	
Output	Off-state Output Terminal Voltage	V _{OFF}	JOCSR21X	600	V
			JOCSR31X	800	
	Peak On-state Current (100μs pulse, 120 pps)	I _{TP}	2	A	
	On-state RMS Current	I _{T(RMS)}	100	mA	
	Peak Repetitive Surge Current (P _w =10 ms)	I _{TSM}	1.2	A	
Output Power Dissipation	P _O	250	mW		

Total Power Dissipation	P_{tot}	325	mW
Isolation Voltage	V_{iso}	5000 ^②	V _{rms}
Operating Temperature	T_{opr}	-55~110	°C
Junction Temperature	T_j	125	°C
Storage Temperature	T_{stg}	-55~125	°C
Soldering Temperature	T_{sol}	260	°C
Peak pulse voltage ($T_j=25^{\circ}C$; non-repetitive,off-state)	V_{pp}	1	kV

NOTE1: μ

NOTE2:

ELECTRICAL CHARACTERISTICS (Temperature=25°C)

Parameter		Symbol	Condition	Min.	Typ.	Max.	Unit
Input	Forward Voltage	V_F	$I_F=10mA$	-	1.2	1.5	V
	Reverse Current	I_R	$V_R=6V$	-	-	1	μA
	Input Capacitance	C_{in}	$V=0, f=1kHz$	-	10	-	pF
Output	Peak Off-state Current, Either Direction	I_{OFF}	$V_{OFF}=Rated V_{OFF}$ $I_F=0$	-	-	100 ^③	nA
	Peak On-state Voltage, Either Direction	V_{TM}	$I_{TM}=100mA$	-	1.8	2.5	V
	Critical Rate of Rise of Off-state voltage	dV/dt	$V_{PEAK}= Rated V_{PEAK}$ $I_F=0$	2000 ^④	-	-	V/ μs
Transfer Characteristics	LED Trigger Current	JOCSR21A JOCSR31A	Terminal Voltage=3V $I_{TM}=100mA$	-	-	10	mA
		JOCSR21B JOCSR31B		-	-	5	
		JOCSR21C JOCSR31C		-	-	3	
	Holding Current	I_H	$I_{TM}=2mA,$ $I_F=Rated I_{FT}$	-	500	-	μA
	Isolation Resistance	R_{iso}	DC500V 40~60%R.H.	10^{12}	10^{14}	-	
	Floating Capacitance	C_{io}	$V=0,$ $f=1MHz$	-	5	-	pF
Response Time	t_{on}	$V_D=6V,$ $R_L=100 \Omega,$ $I_F=20mA$	-	15	50	μs	

NOTE3:

NOTE4:

ORDERING INFORMATION

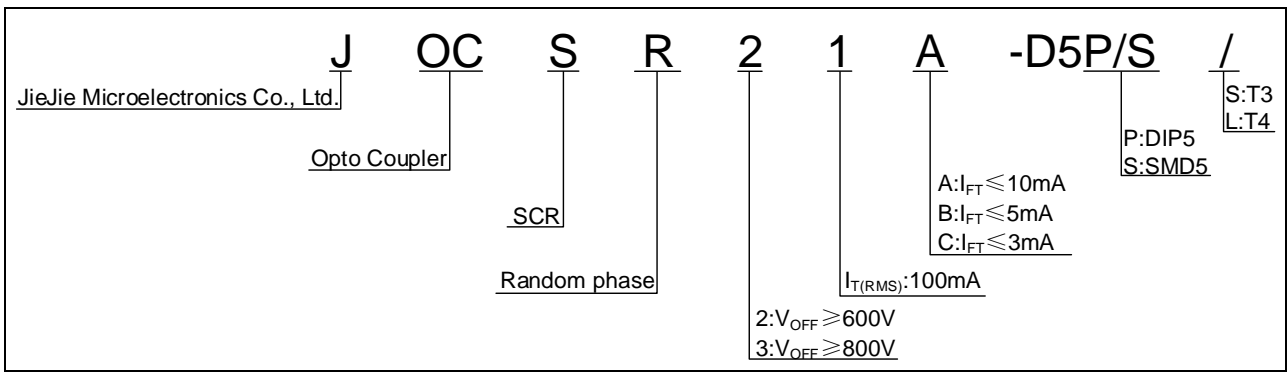

Packing Quantity	
Option	Quantity

MARKING

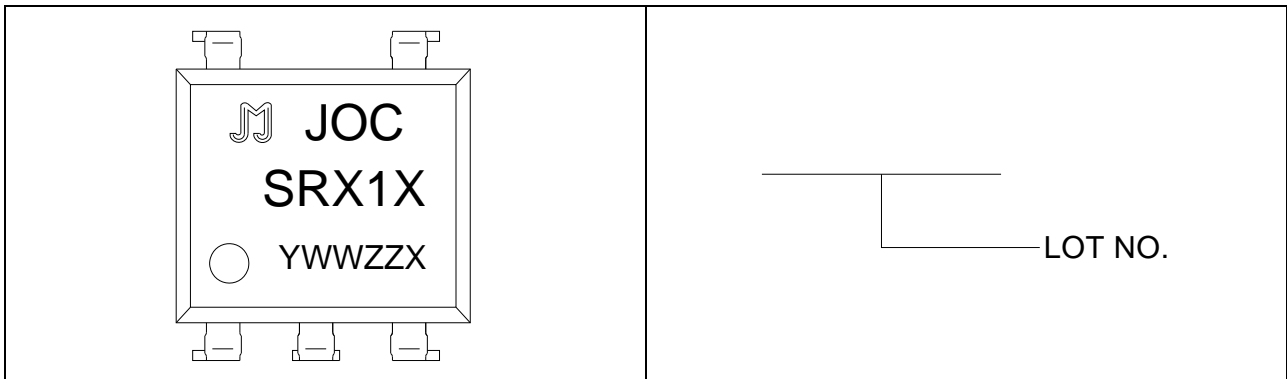

Characteristics Curves

FIG.1: Max. Allowable LED Forward Current vs. Ambient Temperature

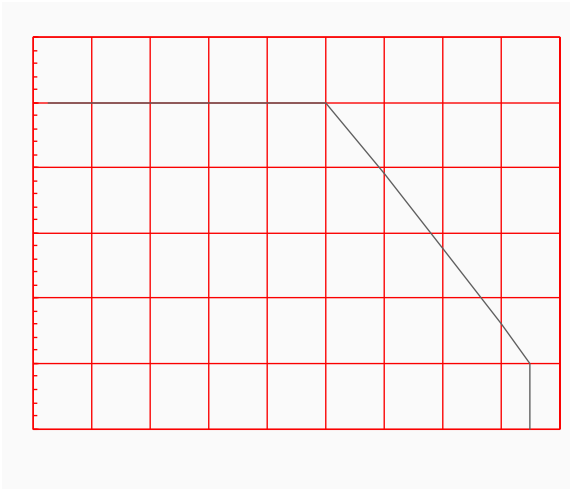

FIG.2: On-state Terminal Current vs. Ambient Temperature

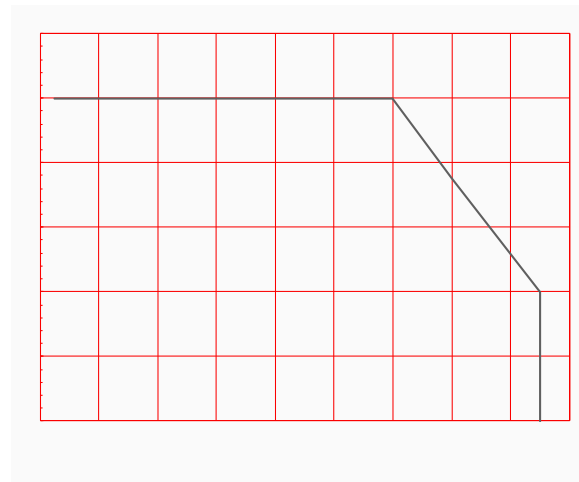

FIG.3: Forward Current vs. Forward Voltage

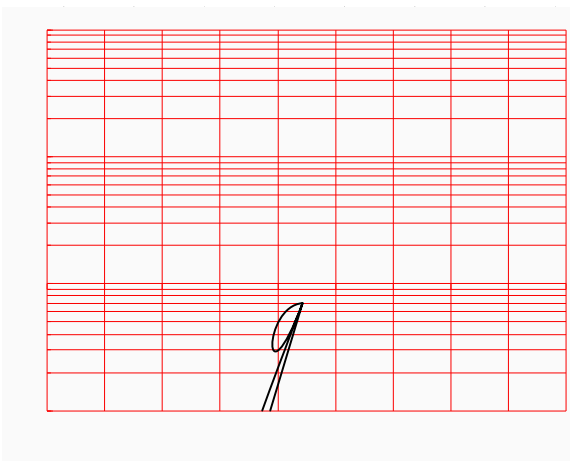

FIG.4: Normalized Off-state Terminal Current vs. Ambient Temperature

JC

FIG
An

vs.

FIG.8: On-state Terminal Voltage vs. On-state Terminal Current

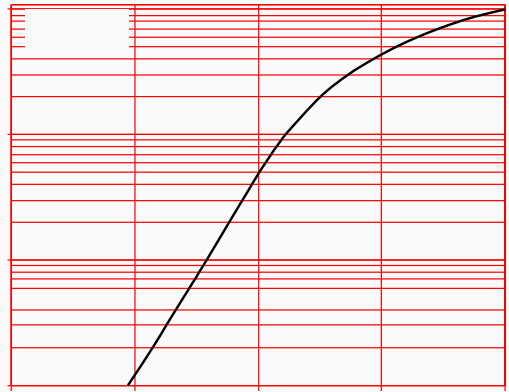

FIG
Te

nt

FIG.10: Turn On Time vs. Forward Current

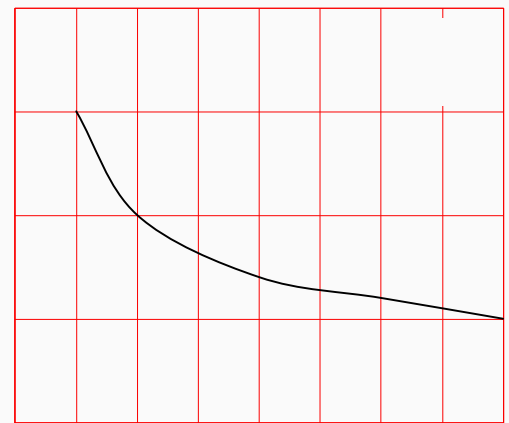

FIG
Te

nt

TEST CIRCUITS

FIG.12: Test Circuits of Turn On Time

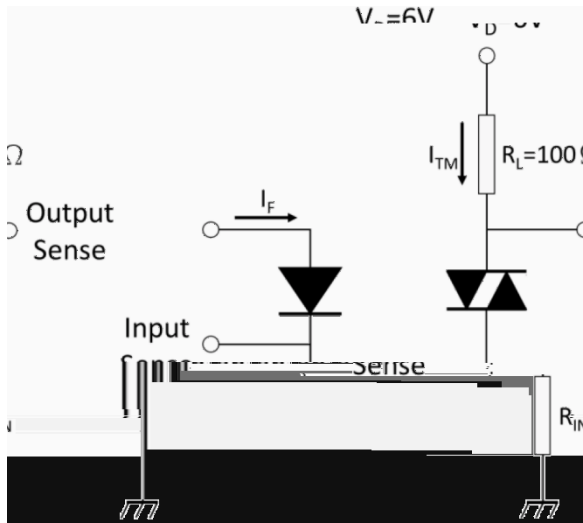

FIG.13: Waveforms of Turn On Time

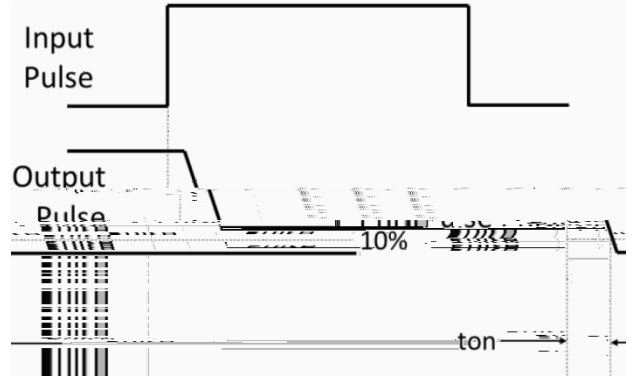

Fig.14: Test Circuits of dV/dt

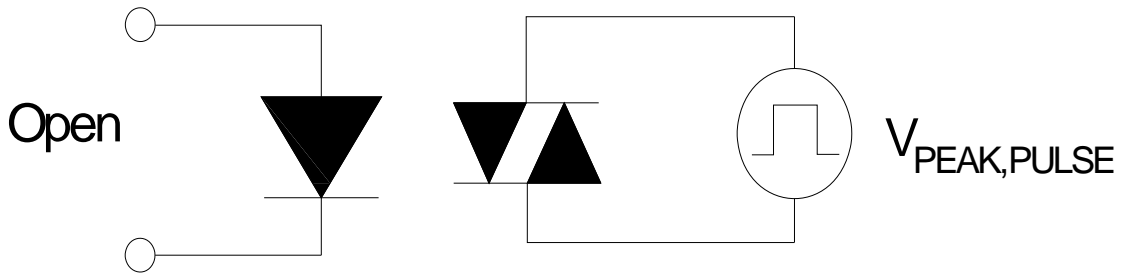

Fig.15: Waveforms of dV/dt

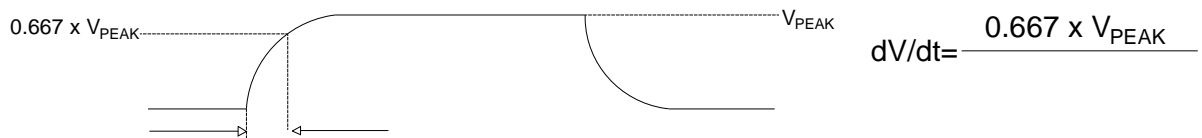
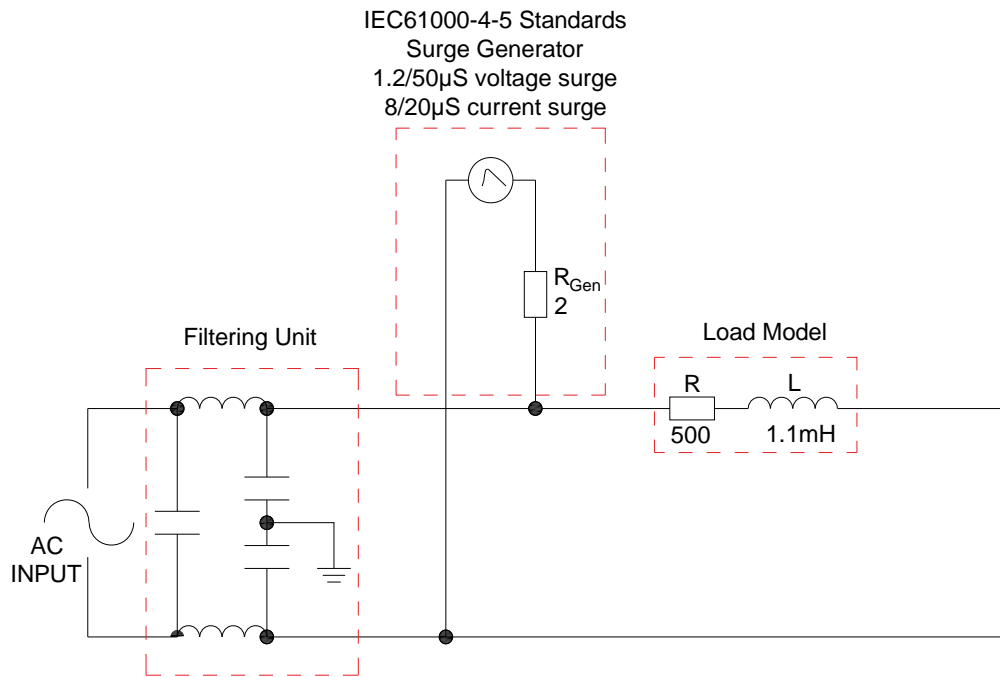
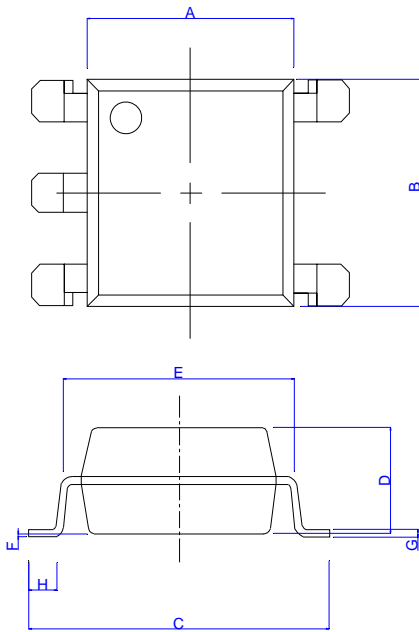

FIG.16: Test circuit for inductive and resistive loads to IEC-61000-4-5 standards



Option SMD Type:



Ref.	Dimensions					
	Millimeters			Inches		
	Min.	Typ.	Max.	Min.	Typ.	Max.
A	6.20		6.60	0.244		0.260
B	6.92		7.32	0.272		0.288
C	9.50		10.50	0.375		0.413
D	3.20		3.60	0.126		0.142
E	7.32		7.92	0.288		0.312
F	0.05		0.35	0.002		0.014
G	0.16		0.36	0.006		0.014
H	0.60		1.40	0.024		0.055
I	0.90		1.50	0.035		0.059
J	3.30		3.90	0.130		0.154
K	2.29		2.79	0.090		0.110

RECOMMENDED SOLDER MASK (Dimensions in mm unless otherwise stated)

Option SMD

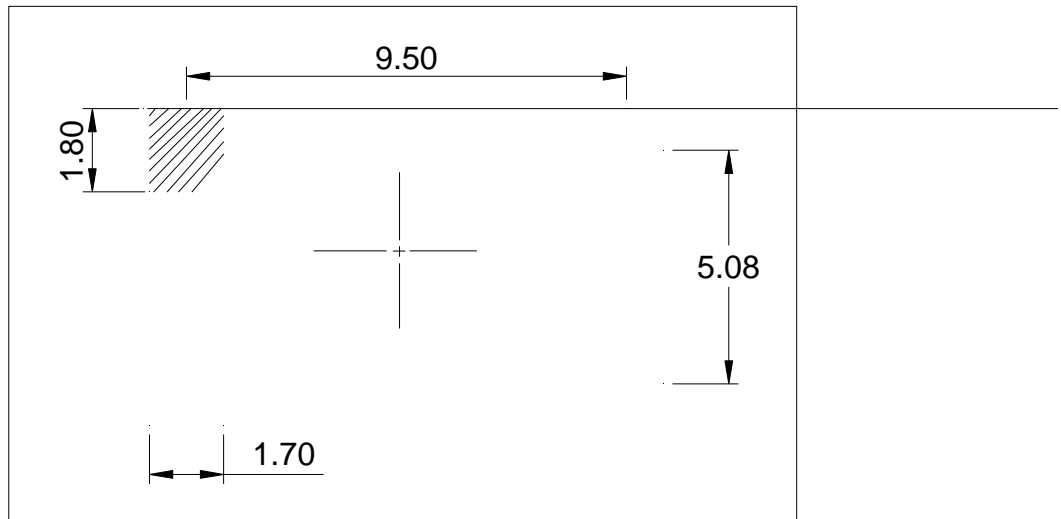

TUBE SPECIFICATIONS (Dimensions in mm unless otherwise stated)

Standard DIP

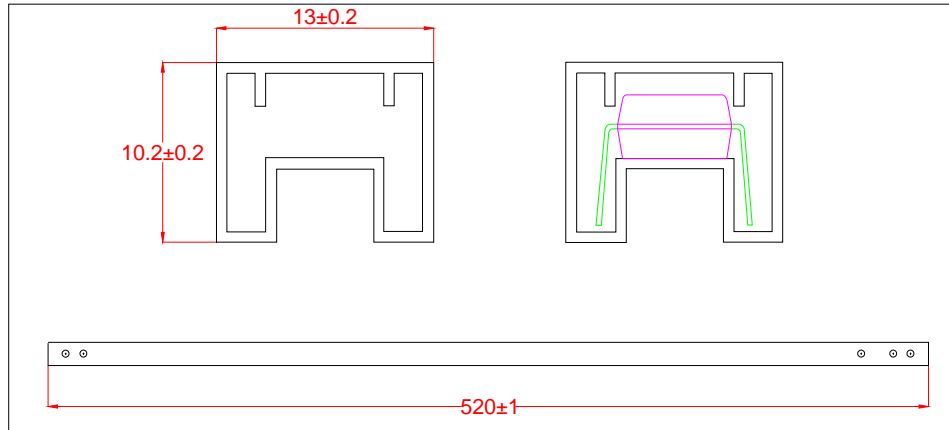

CARRIER TAPE SPECIFICATIONS (Dimensions in mm unless otherwise stated)

Option S/L

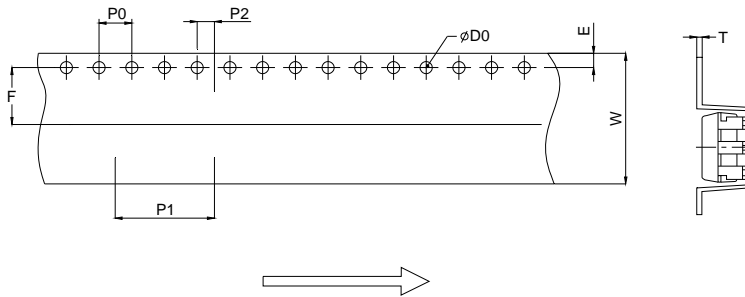

Ref.	Dimensions					
	Millimeters			Inches		
	Min.	Typ.	Max.	Min.	Typ.	Max.
D0		1.50	1.60		0.059	0.063
P0	3.90	4.00	4.10	0.154	0.157	0.161
P1	11.90	12.00	12.10	0.469	0.472	0.476
P2	1.90	2.00	2.10	0.075	0.079	0.083
E	1.65	1.75	1.85	0.065	0.069	0.073
F	7.40	7.50	7.60	0.291	0.295	0.299
T	0.35	0.40	0.45	0.014	0.016	0.018
W	15.70	16.00	16.30	0.618	0.630	0.642

REFLOW INFORMATION

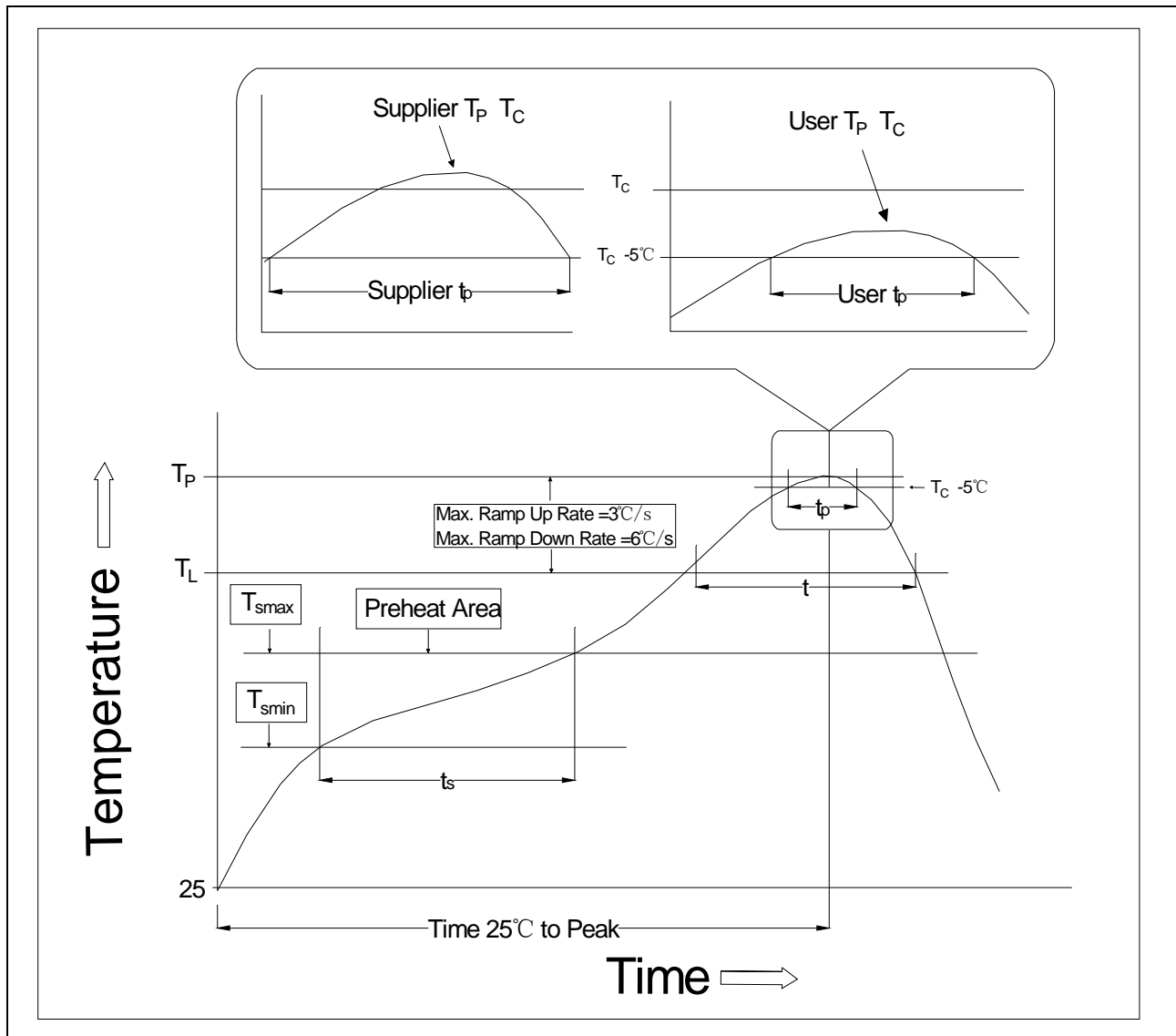

Profile Feature	Sn-Pb Assembly Profile	Pb-Free Assembly Profile
Temperature Min. (T _{smin})	100	150°C
Temperature Max. (T _{smax})	150	200°C
Time (t _s) from (T _{smin} to T _{smax})	60-120 seconds	60-120 seconds
Ramp-up Rate (t _L to t _P)	3°C/second max.	3°C/second max.
Liquidus Temperature (T _L)	183°C	217°C
Time (t _L) Maintained Above (T _L)	60-150 seconds	60-150 seconds
Peak Body Package Temperature	235°C+0°C/-5°C	260°C+0°C/-5°C
Time (t _P) within 5°C of 260°C	20 seconds	30 seconds
Ramp-down Rate (T _P to T _L)	6°C/second max.	6°C/second max.
Time 25°C to Peak Temperature	6 minutes max.	8 minutes max.

WAVE SOLDERING

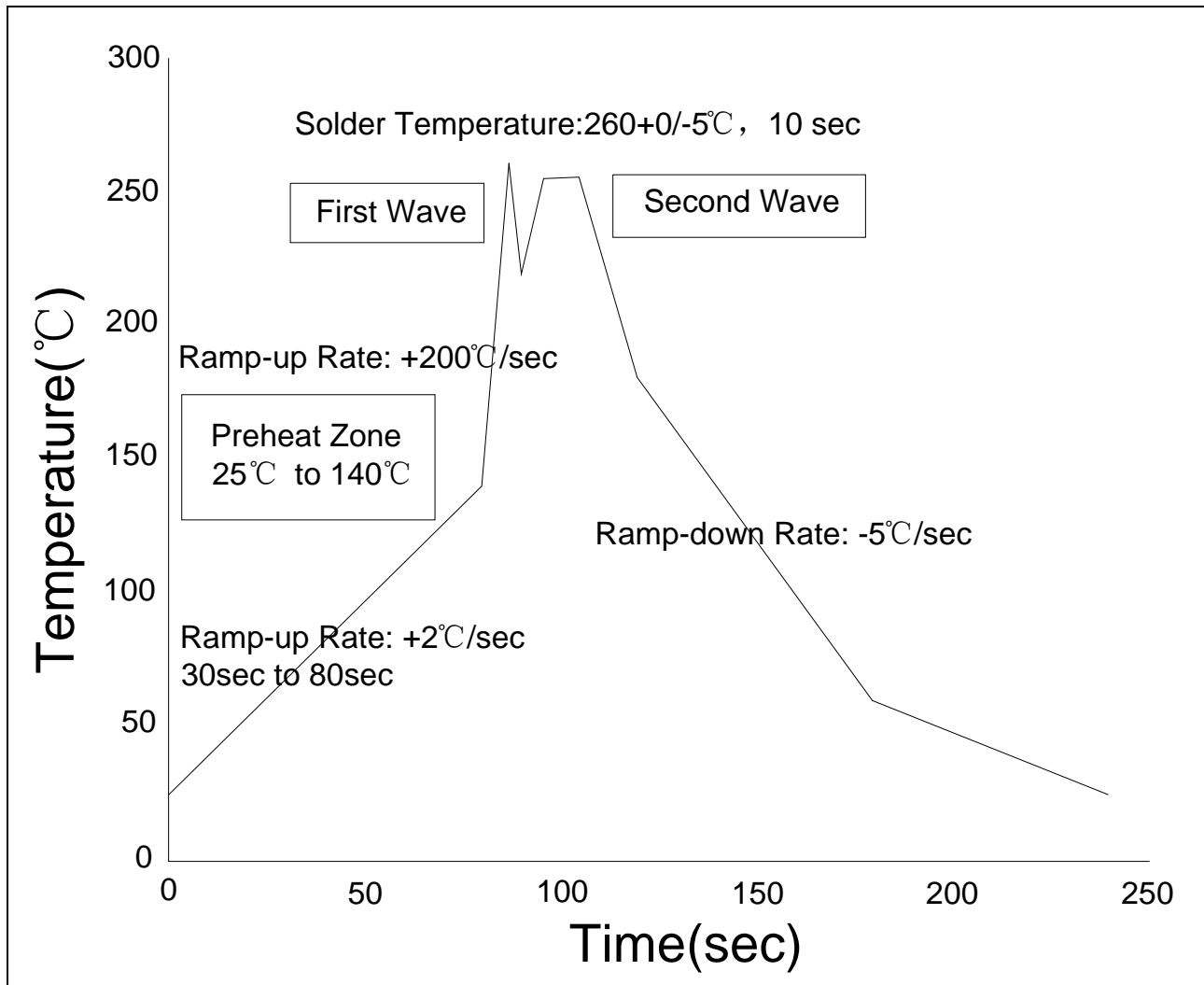

HAND SOLDERING BY SOLDERING IRON

Soldering Temperature	$360 \pm 5^{\circ}\text{C}$
Soldering Time	3s max.

Note:

1. Reflow soldering is recommended at the temperatures and times shown, no more than three times.
2. Avoid direct contact between the epoxy body and any tools or surfaces exceeding its maximum storage temperature.
3. Application of pressure on the epoxy body is prohibited at elevated temperatures. In specific scenarios, any applied force must not exceed 2.5N.
4. Ensure the component has cooled to ambient temperature before proceeding with any subsequent manufacturing steps.
5. The component has a shelf life of one year when stored under standard conditions.
6. Recommend storage Temp.: 0~40°C;
Recommend storage humidity: <60%;
MSL level: MSL 1

Information furnished in this document is believed to be accurate and reliable. However, Jiangsu JieJie Microelectronics Co., Ltd. assumes no responsibility for the consequences of use without consideration for such information nor use beyond it. Information mentioned in this document is subject to change without notice, apart from that when an agreement is signed, Jiangsu JieJie complies with the agreement.

Products and information provided in this document have no infringement of patents. Jiangsu JieJie assumes no responsibility for any infringement of other rights of third parties which may result from the use of such products and information. This document supersedes and replaces all information previously supplied.

 is a registered trademark of Jiangsu JieJie Microelectronics Co., Ltd.

Copyright © 2026 Jiangsu JieJie Microelectronics Co., Ltd. All rights reserved.