





			°C
			°C

: 100 μ s pulse, 100Hz frequency

: AC for 1 minute, R.H. = 40~60%

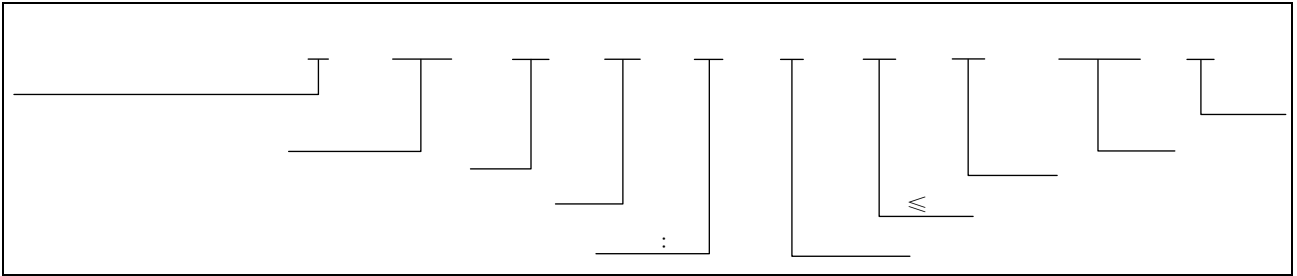

None/R	3000 Units/Reel

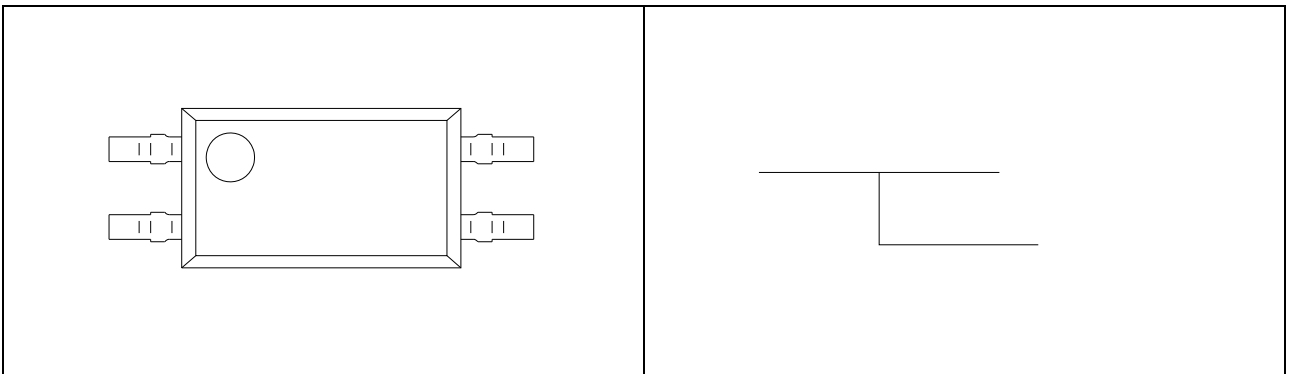

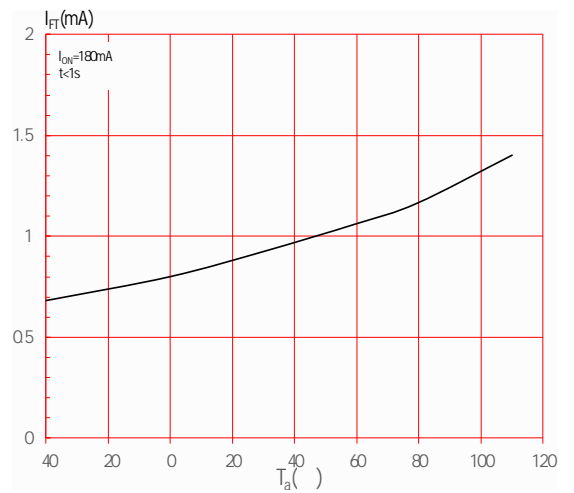
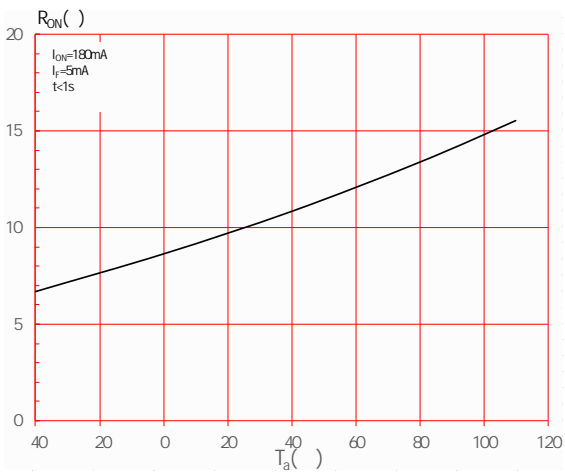
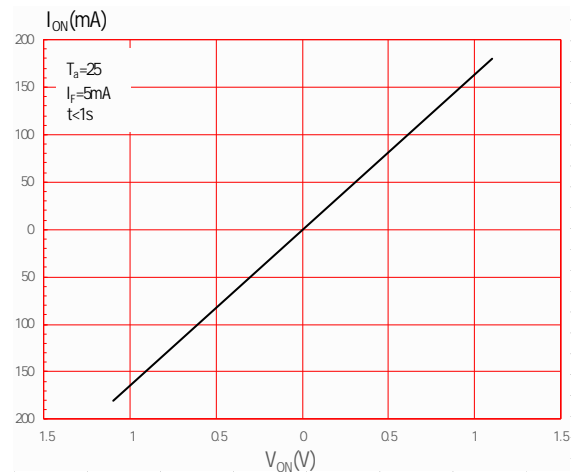
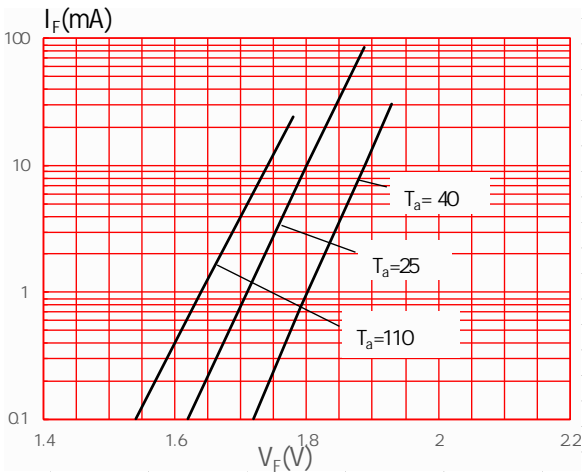
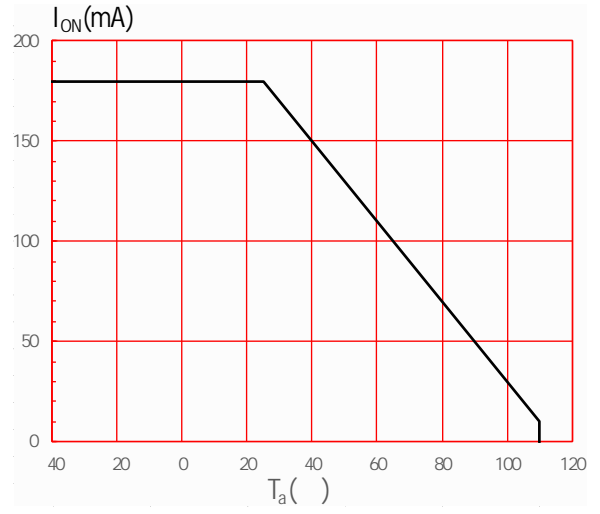
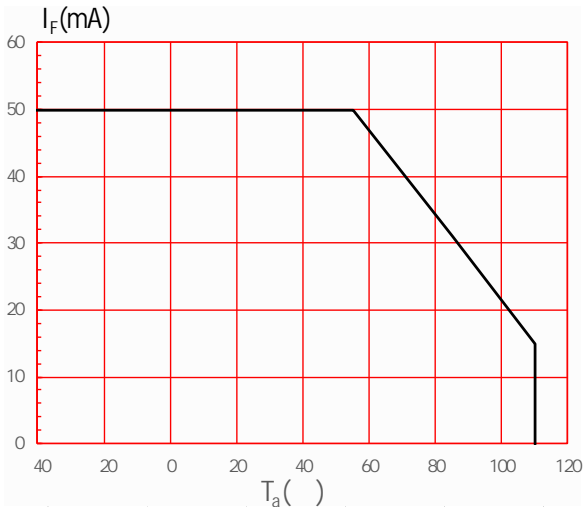

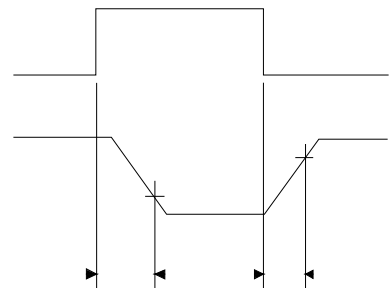
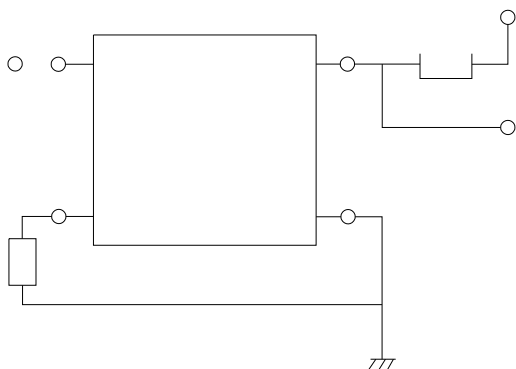
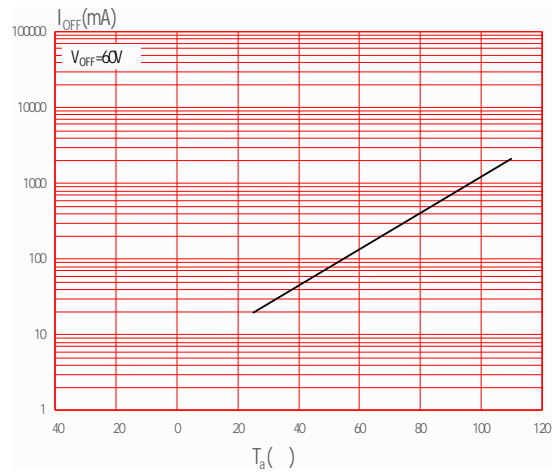
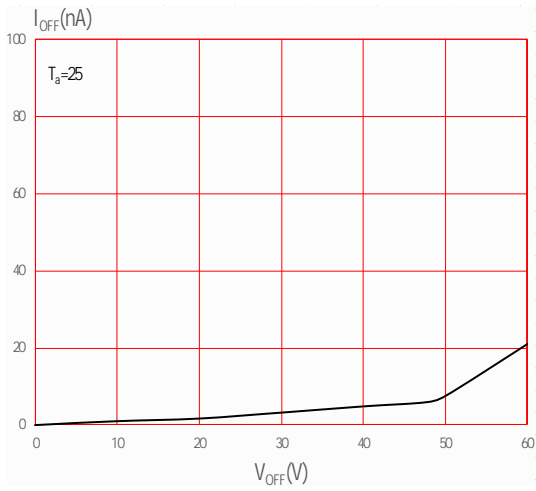
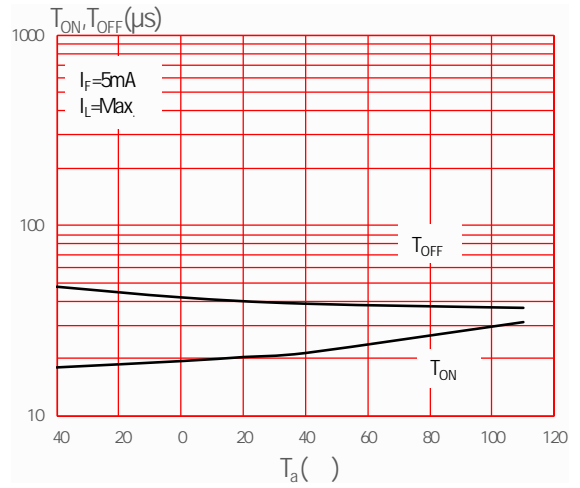
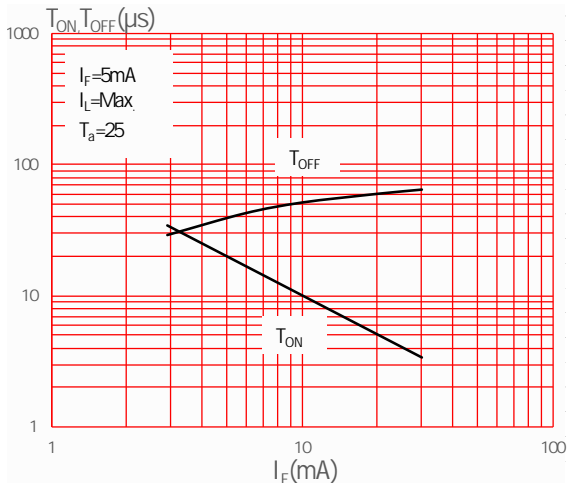

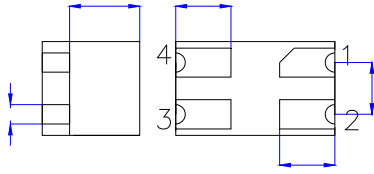
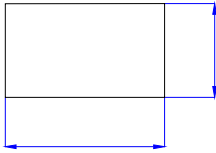
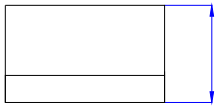

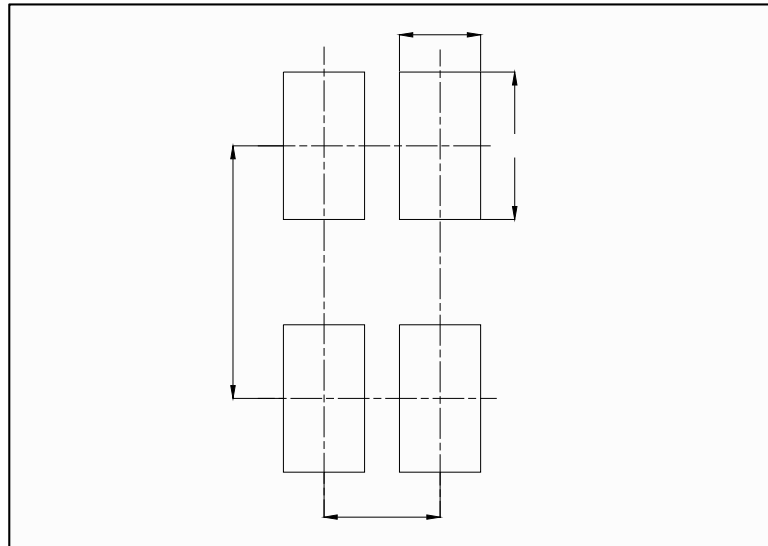



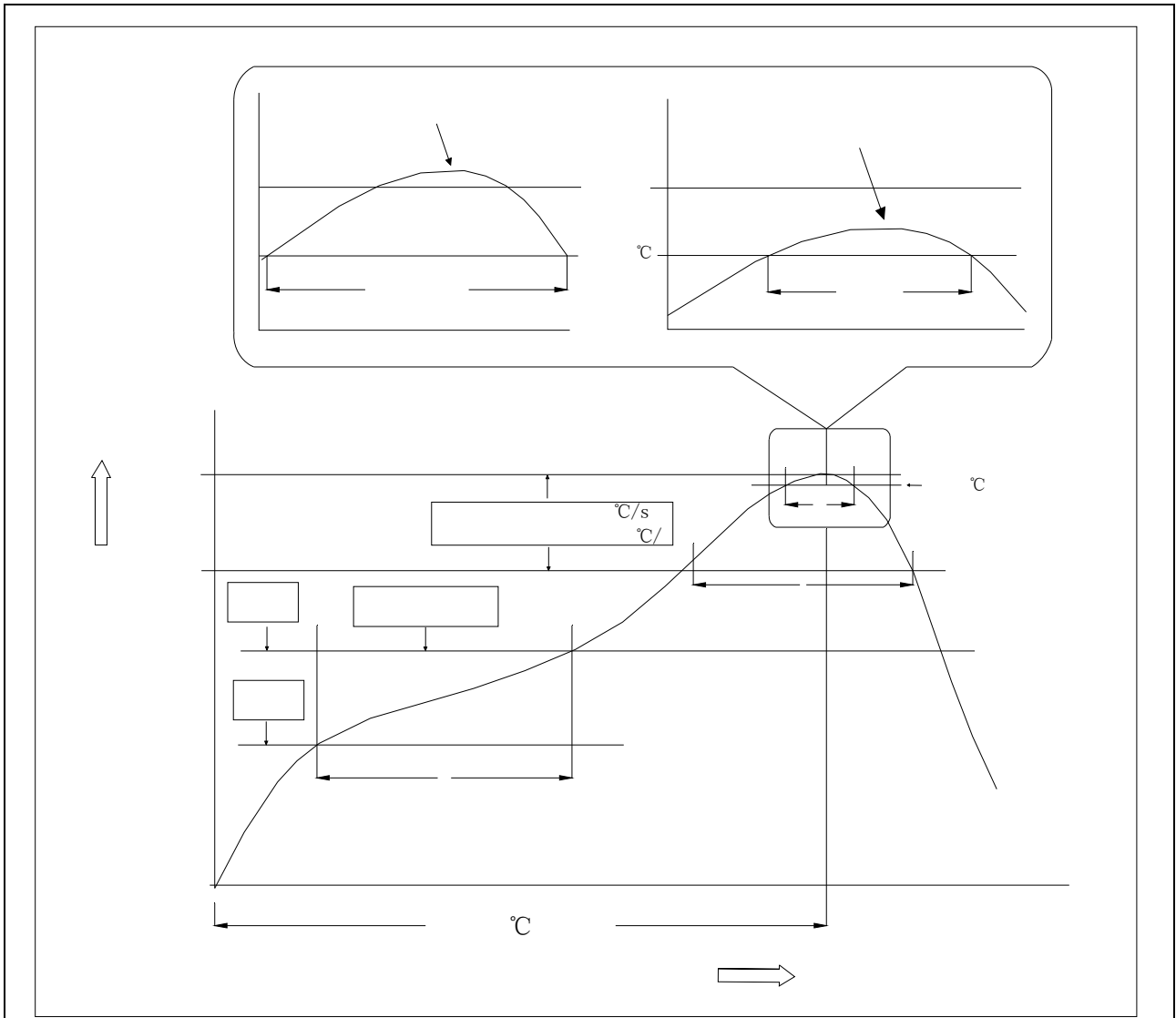

		°C
		°C
	°C	°C
	°C	°C
	°C °C °C	°C °C °C
°C °C		
	°C	°C
°C		

